

Dual 1 Form A Solid State Relay

Features

- Two Independent Relays
 - Current Limit Protection
 - Isolation Test Voltage 5300 V_{RMS}
 - Typical R_{ON} 15 Ω
 - Load Voltage 250 V
 - Load Current 120 mA
 - High Surge Capability
 - Clean Bounce Free Switching
 - Low Power Consumption
 - High Reliability Monolithic Receptor
-
- SMD Lead Available on Tape and Reel
 - Lead-free component
 - Component in accordance to RoHS 2002/95/EC and WEEE 2002/96/EC

Agency Approvals

- UL1577, File No. E52744 System Code H or J, Double Protection
- CSA - Certification 093751
- BSI/BABT Cert. No. 7980
- DIN EN 60747-5-2 (VDE0884)
DIN EN 60747-5-5 pending
- FIMKO Approval

Applications

General Telecom Switching

- On/off Hook Control
- Ring Delay
- Dial Pulse
- Ground Start
- Ground Fault Protection

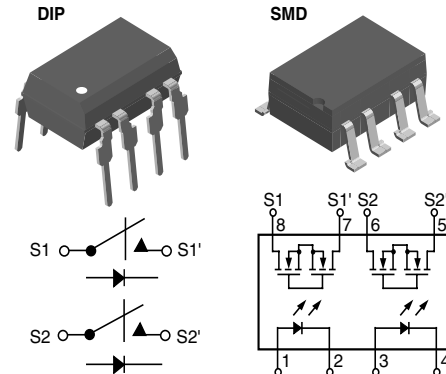

1179034



Instrumentation
Industrial Controls

Description

The LH1505 contains two normally open switches that can be used as two independent SPST relays or as one DPST relay. The relay is constructed using a GaAlAs LED for actuation control and integrated monolithic dies for the switch outputs. The die, fabricated in a high-voltage dielectrically isolated technology, is comprised of a photodiode array, switch control circuitry, and DMOS switches. In addition, the LH1505 relay employs current limiting circuitry, enabling it to pass FCC 68.302 and other regulatory voltage surge requirements when overvoltage protection is provided.

Order Information

Part	Remarks
LH1505AAC	Tubes, SMD-8
LH1505AACTR	Tape and Reel, SMD-8
LH1505AB	Tubes, SMD-8

Absolute Maximum Ratings, $T_{amb} = 25\text{ }^{\circ}\text{C}$

Stresses in excess of the absolute Maximum Ratings can cause permanent damage to the device. Functional operation of the device is not implied at these or any other conditions in excess of those given in the operational sections of this document. Exposure to absolute Maximum Ratings for extended periods of time can adversely affect reliability.

SSR

Parameter	Test condition	Symbol	Value	Unit
LED continuous forward current		I_F	50	mA
LED reverse voltage	$I_R \leq 10\text{ }\mu\text{A}$	V_R	8.0	V
DC or peak AC load voltage	$I_L \leq 50\text{ }\mu\text{A}$	V_L	250	V
Continuous DC load current , one pole operating		I_L	130	mA
Continuous DC load current , two poles operating		I_L	120	mA
Peak load current (single shot), Form B	$t = 100\text{ ms}$	I_P	2)	
Ambient operating temperature range		T_{amb}	- 40 to + 85	$^{\circ}\text{C}$
Storage temperature range		T_{stg}	- 40 to + 150	$^{\circ}\text{C}$
Pin soldering temperature	$t = 10\text{ s max}$	T_{sld}	260	$^{\circ}\text{C}$
Input/output isolation test voltage	$t = 1.0\text{ s}, I_{ISO} = 10\text{ }\mu\text{A max}$	V_{ISO}	5300	V_{RMS}
Pole-to-pole isolation voltage (S1 to S2) ¹⁾ , (dry air, dust free, at sea level)			1600	V
Output power dissipation (continuous)		P_{diss}	600	mW

¹⁾ Breakdown occurs between the output pins external to the package.

²⁾ Refer to Current Limit Performance Application Note for a discussion on relay operation during transient currents.

Electrical Characteristics, $T_{amb} = 25\text{ }^{\circ}\text{C}$

Minimum and maximum values are testing requirements. Typical values are characteristics of the device and are the result of engineering evaluations. Typical values are for information only and are not part of the testing requirements.

Input

Parameter	Test condition	Symbol	Min	Typ.	Max	Unit
LED forward current, switch turn-on	$I_L = 100\text{ mA}, t = 10\text{ ms}$	I_{Fon}		1.0	2.0	mA
LED forward current, switch turn-off	$V_L = \pm 200\text{ V}$	I_{Foff}	0.2	0.9		mA
LED forward voltage	$I_F = 10\text{ mA}$	V_F	1.15	1.26	1.45	V

Output

Parameter	Test condition	Symbol	Min	Typ.	Max	Unit
ON-resistance	$I_F = 5.0\text{ mA}, I_L = 50\text{ mA}$	R_{ON}	10	15	20	Ω
OFF-resistance	$I_F = 0\text{ mA}, V_L = \pm 100\text{ V}$	R_{OFF}	0.5	5000		$G\Omega$
Current limit	$I_F = 5.0\text{ mA}, t = 5.0\text{ ms},$ $V_L = \pm 6.0\text{ V}$	I_{LMT}	170	200	280	mA
Off-state leakage current	$I_F = 0\text{ mA}, V_L = \pm 100\text{ V}$	I_O		0.02	200	nA
	$I_F = 0\text{ mA}, V_L = \pm 250\text{ V}$	I_O			1.0	μA

Parameter	Test condition	Symbol	Min	Typ.	Max	Unit
Output capacitance	$I_F = 0 \text{ mA}, V_L = 1.0 \text{ V}$	C_O		55		pF
	$I_F = 0 \text{ mA}, V_L = 50 \text{ V}$	C_O		10		pF
Pole-to-pole capacitance (S1 to S2)	$I_F = 5.0 \text{ mA}$			0.5		pF
Switch offset	$I_F = 5.0 \text{ mA}$	V_{OS}		0.15		V

Transfer

Parameter	Test condition	Symbol	Min	Typ.	Max	Unit
Capacitance (input-output)	$V_{ISO} = 1.0 \text{ V}$	C_{IO}		1.1		pF
Turn-on time	$I_F = 5.0 \text{ mA}, I_L = 50 \text{ mA}$	t_{on}		1.4 ¹⁾	4.0 ¹⁾	ms
Turn-off time	$I_F = 5.0 \text{ mA}, I_L = 50 \text{ mA}$	t_{off}		0.7 ¹⁾	4.0 ¹⁾	ms

¹⁾ $I_L = 100 \text{ mA}$

Typical Characteristics ($T_{amb} = 25^\circ\text{C}$ unless otherwise specified)

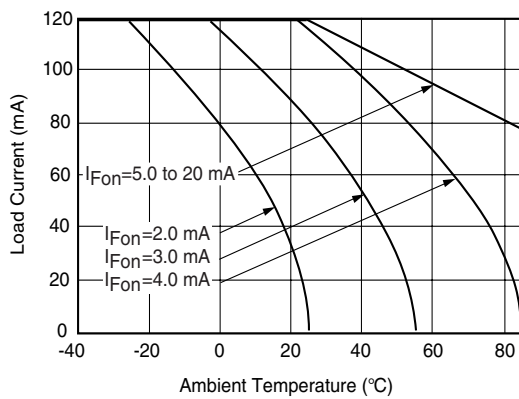

ih1505ab_00

Figure 1. Recommended Operating Conditions

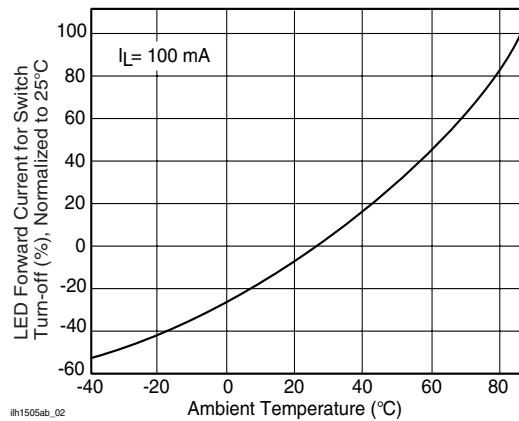

ih1505ab_02

Figure 3. LED Current for Switch Turn-on vs. Temperature

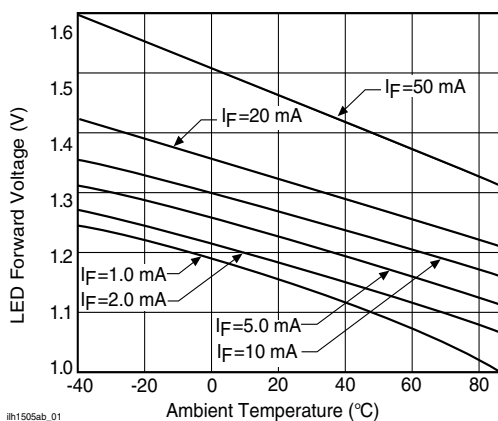

ih1505ab_01

Figure 2. LED Voltage vs. Temperature

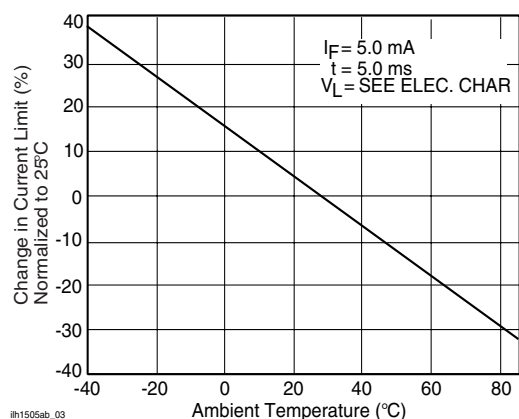

ih1505ab_03

Figure 4. Current Limit vs. Temperature

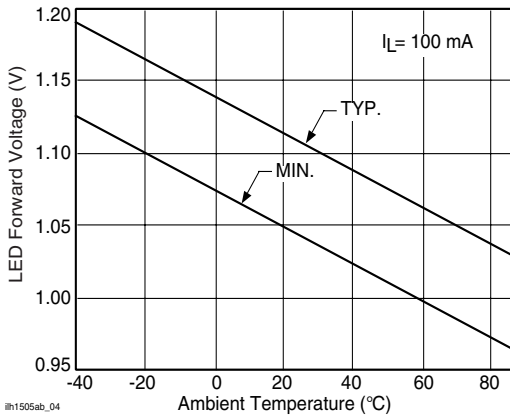

Figure 5. LED Dropout Voltage vs. Temperature

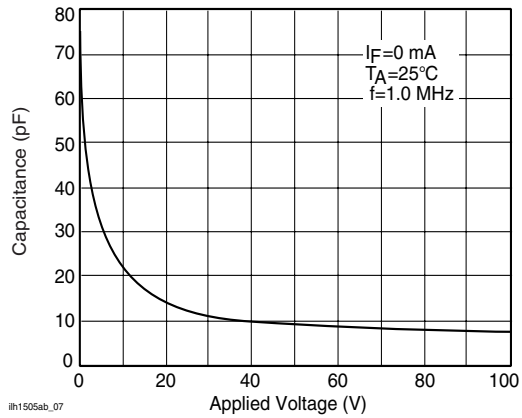

Figure 8. Switch Capacitance vs. Applied Voltage

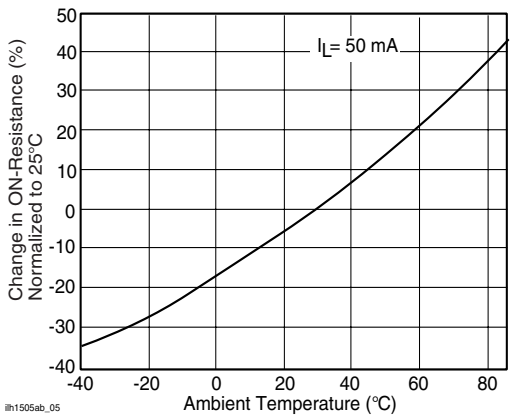

Figure 6. ON-Resistance vs. Temperature

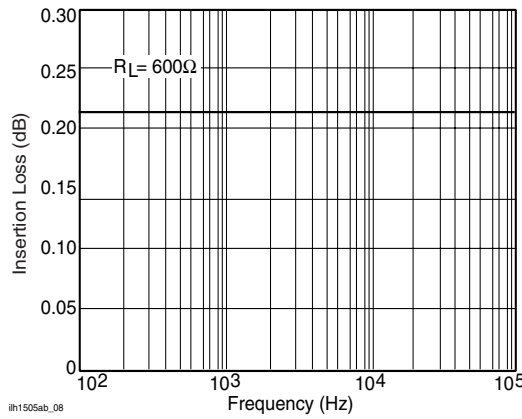

Figure 9. Insertion Loss vs. Frequency

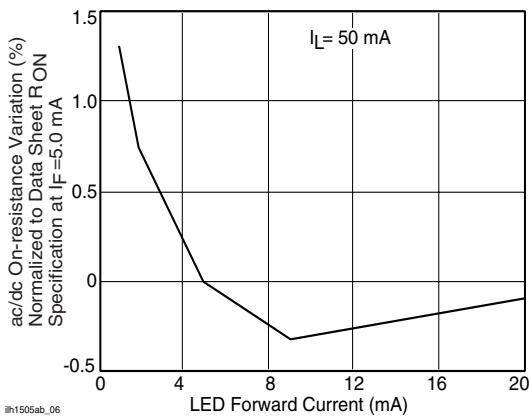

Figure 7. Variation in ON-Resistance vs. LED Current

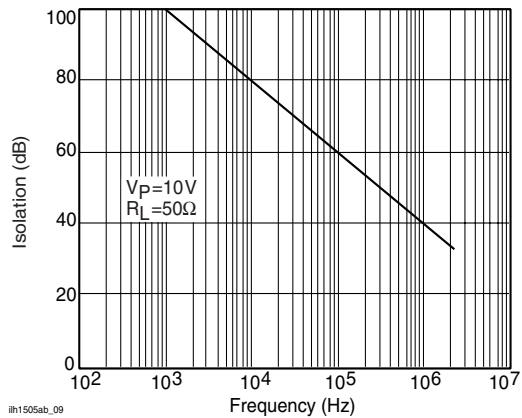

Figure 10. Output Isolation

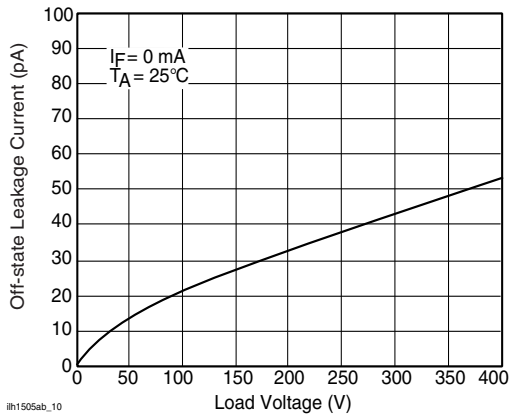

Figure 11. Leakage Current vs. Applied Voltage

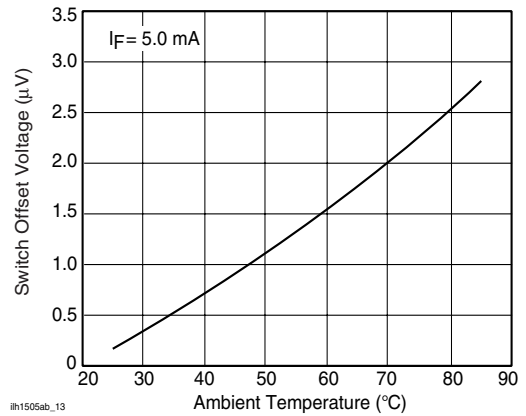

Figure 14. Switch Offset Voltage vs. Temperature

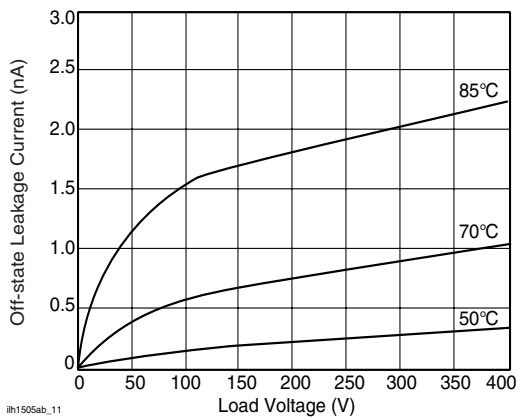

Figure 12. Leakage Current vs. Applied Voltage at Elevated Temperatures

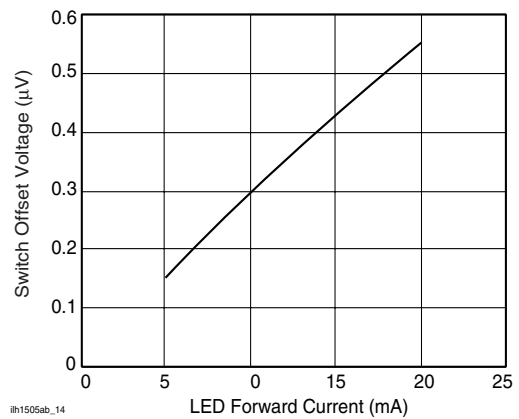

Figure 15. Switch Offset Voltage vs. LED Current

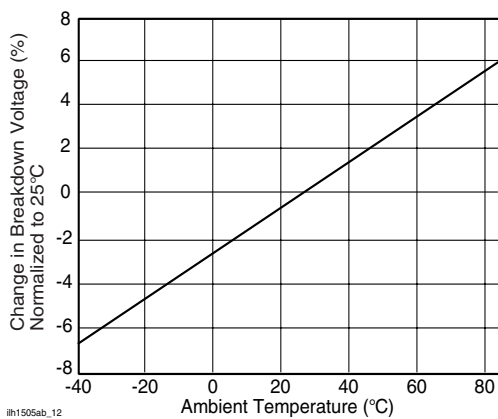

Figure 13. Switch Breakdown Voltage vs. Temperature

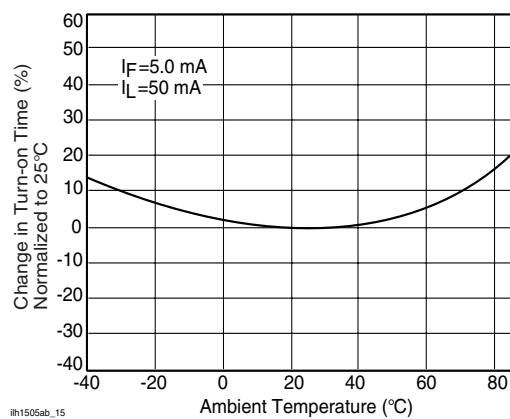

Figure 16. Turn-on Time vs. Temperature

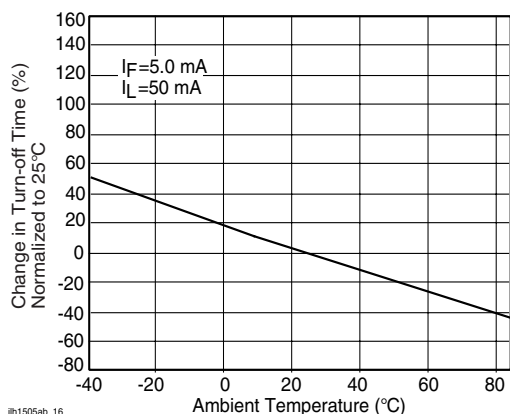

Figure 17. Turn-off Time vs. Temperature

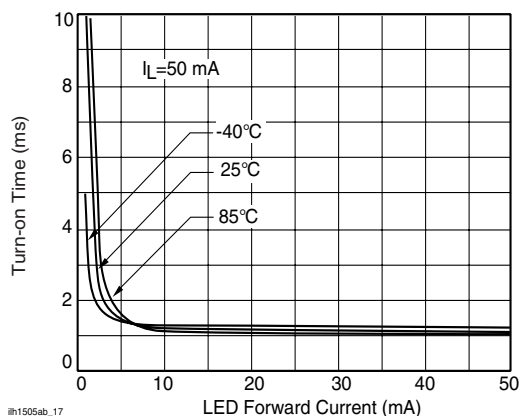

Figure 18. Turn-on Time vs. LED Current

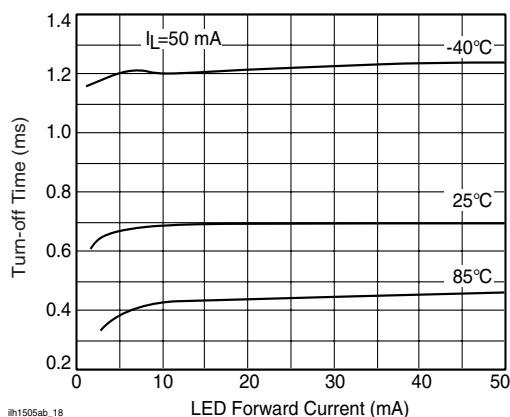
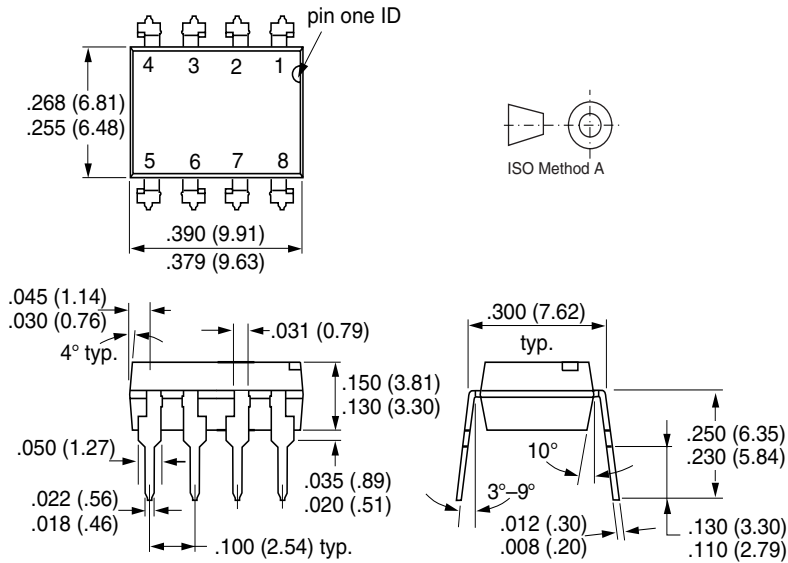

Figure 19. Turn-off Time vs. LED Current

Package Dimensions in Inches (mm)

DIP



i178008

Package Dimensions in Inches (mm)

SMD

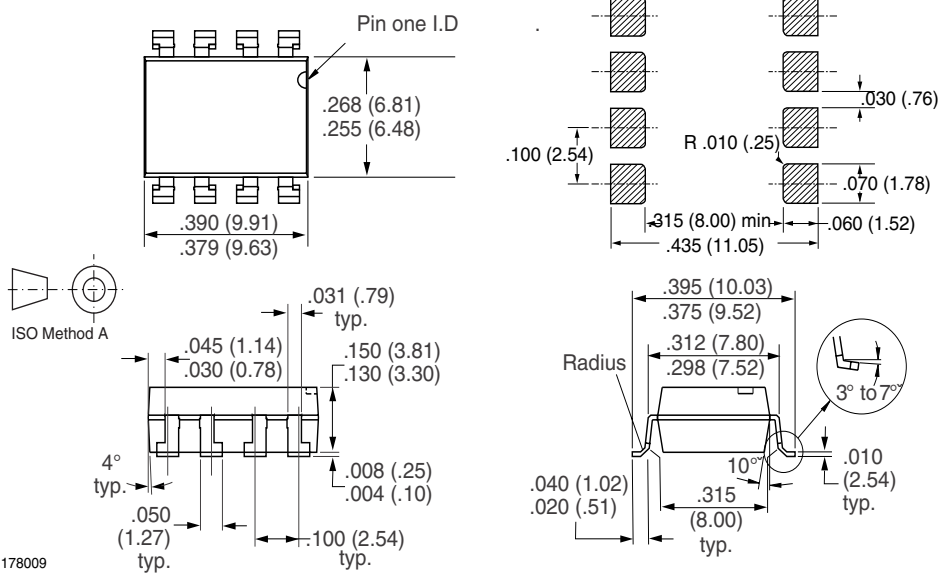

i178009

Ozone Depleting Substances Policy Statement

It is the policy of Vishay Semiconductor GmbH to

1. Meet all present and future national and international statutory requirements.
2. Regularly and continuously improve the performance of our products, processes, distribution and operating systems with respect to their impact on the health and safety of our employees and the public, as well as their impact on the environment.

It is particular concern to control or eliminate releases of those substances into the atmosphere which are known as ozone depleting substances (ODSs).

The Montreal Protocol (1987) and its London Amendments (1990) intend to severely restrict the use of ODSs and forbid their use within the next ten years. Various national and international initiatives are pressing for an earlier ban on these substances.

Vishay Semiconductor GmbH has been able to use its policy of continuous improvements to eliminate the use of ODSs listed in the following documents.

1. Annex A, B and list of transitional substances of the Montreal Protocol and the London Amendments respectively
2. Class I and II ozone depleting substances in the Clean Air Act Amendments of 1990 by the Environmental Protection Agency (EPA) in the USA
3. Council Decision 88/540/EEC and 91/690/EEC Annex A, B and C (transitional substances) respectively.

Vishay Semiconductor GmbH can certify that our semiconductors are not manufactured with ozone depleting substances and do not contain such substances.

We reserve the right to make changes to improve technical design
and may do so without further notice.

Parameters can vary in different applications. All operating parameters must be validated for each customer application by the customer. Should the buyer use Vishay Semiconductors products for any unintended or unauthorized application, the buyer shall indemnify Vishay Semiconductors against all claims, costs, damages, and expenses, arising out of, directly or indirectly, any claim of personal damage, injury or death associated with such unintended or unauthorized use.

Vishay Semiconductor GmbH, P.O.B. 3535, D-74025 Heilbronn, Germany
Telephone: 49 (0)7131 67 2831, Fax number: 49 (0)7131 67 2423



Disclaimer

All product specifications and data are subject to change without notice.

Vishay Intertechnology, Inc., its affiliates, agents, and employees, and all persons acting on its or their behalf (collectively, "Vishay"), disclaim any and all liability for any errors, inaccuracies or incompleteness contained herein or in any other disclosure relating to any product.

Vishay disclaims any and all liability arising out of the use or application of any product described herein or of any information provided herein to the maximum extent permitted by law. The product specifications do not expand or otherwise modify Vishay's terms and conditions of purchase, including but not limited to the warranty expressed therein, which apply to these products.

No license, express or implied, by estoppel or otherwise, to any intellectual property rights is granted by this document or by any conduct of Vishay.

The products shown herein are not designed for use in medical, life-saving, or life-sustaining applications unless otherwise expressly indicated. Customers using or selling Vishay products not expressly indicated for use in such applications do so entirely at their own risk and agree to fully indemnify Vishay for any damages arising or resulting from such use or sale. Please contact authorized Vishay personnel to obtain written terms and conditions regarding products designed for such applications.

Product names and markings noted herein may be trademarks of their respective owners.